

Eurofilter NG

Filter unit for dust and chips



Eurofilter NG (NEXT GENERATION)

Eurofilter **NG M/P** 160-200-250-300-350

Eurofilter **NG VS M/P** 200-250-300-350

Eurofilter **NG BRIC M/P** 300-350

Design

Eurofilter NG is a mobile filter unit for the extraction of different dusts and wood chips. It is made of a galvanised or painted sheet metal panel structure with a bag filter stage inside, with the possibility of having automatic mechanical cleaning by means of a **motor vibrator (M)** or **pneumatic** cleaning by compressed air (**P**), and continuous discharge of chips and dust.

Eurofilter NG

16 Models



Highlights

- Discharge of waste and dust into **easily managed** containers.
- Remarkable handling despite its size, thanks to its large-diameter wheels.
- **Maximum** filtration **efficiency**.
- Integrated **high-efficiency** and **soundproofing** fan.
- Available with automatic **cleaning system**.
- **Plug & Play** solution, no assembly required.

Applications

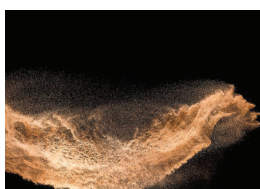

Powders



Wood shavings

Clean air solutions

Eurofilter NG filter units are an effective solution for improving air quality in industrial environments, ensuring high filtration efficiency and operational safety. Thanks to their robust construction and advanced design, they ensure a long service life and practical use. Equipped with an automatic cleaning

system and efficient continuous discharge of dust and swarf, the units help keep the air clean, reducing the risk of pollution and improving working conditions. In addition, the presence of a soundproofing centrifugal fan allows high performance operation while reducing noise impact.



Maintenance

Vertically arranged filter bags ensure easy access and a quick filter maintenance



Filter Media

■ Eurofilter NG

MEDIA	MATERIALS	m ²	g/m ²	STANDARD	OPTIONAL
M PES 500	POLYESTER		500	■	
M PES 550AX	POLYESTER ANTISTATIC		550		■



M PES 500

Principle of operation

Eurofilter NG is a system that adapts to several applications due to its high versatility. Dusty air enters the machine through the pre-chamber, where the coarsest particles, due to gravitational effects, fall into collection bins (**MIP**), or are conveyed into the hopper and discharged by the rotary valve (**VS**) or compacted by the briquetting machine (**BRIC**); the finer particles are retained by the filter bags. The filtered air is exhausted through the upper opening of the machine.

Eurofilter NG

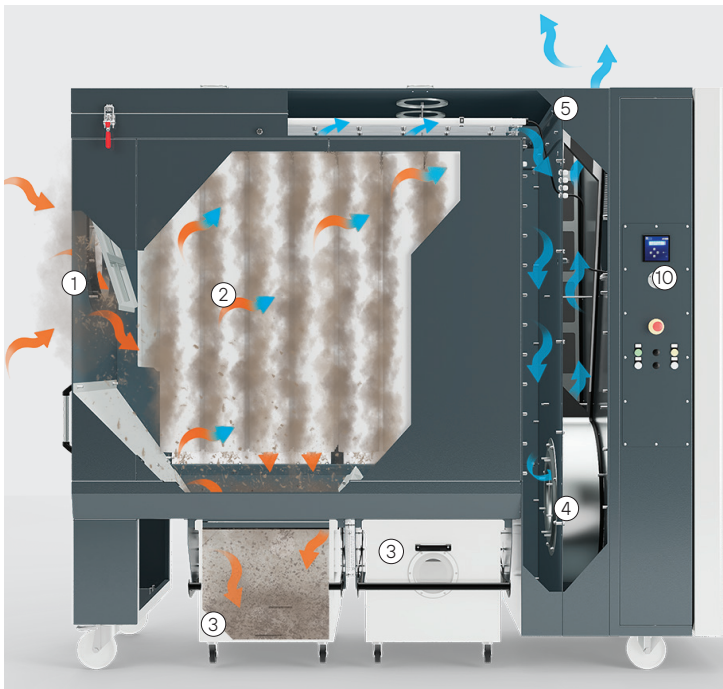

Eurofilter NG M Automatic with motor vibrator

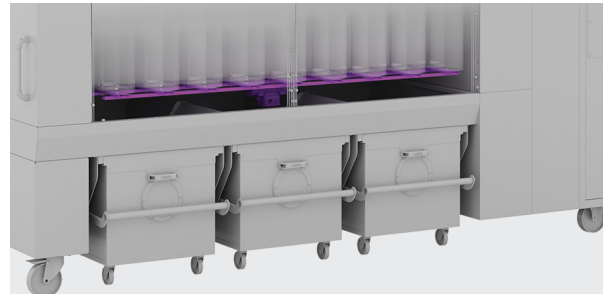

Eurofilter NG P Automatic with pneumatic system

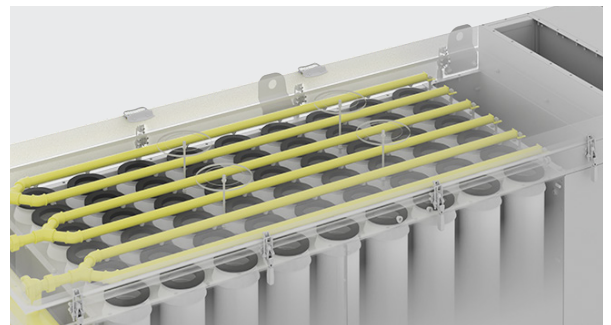

Eurofilter NG VS MIP

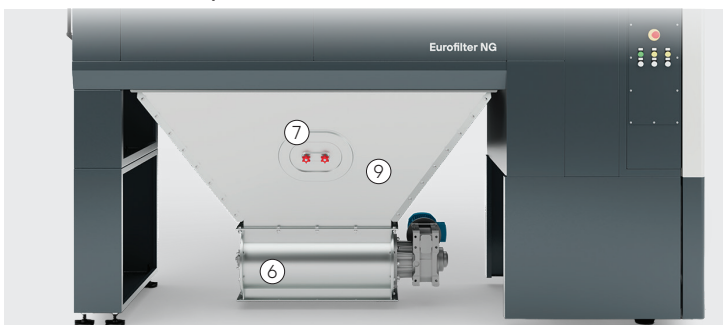

Eurofilter NG BRIC MIP

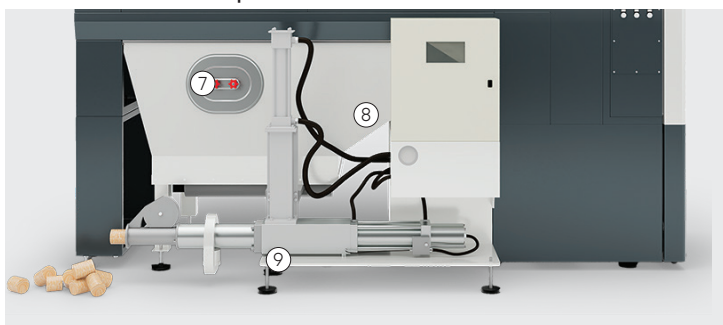

- ① Air inlet with dust
- ② Filter bags
- ③ Collection bins Fan
- ④ Soundproofing plenum on clean side
- ⑤ Air outlet
- ⑥ Rotary valve
- ⑦ Inspection hatch
- ⑧ Single hopper
- ⑨ Briquette machine
- ⑩ Economiser
- ON/OFF switch

Product range



Eurofilter NG M|P

Eurofilter NG is a vertical bag filter for dust extraction and filtration.

Version with collection bins, it is equipped with wheels for easy handling. It guarantees high efficiency thanks to the automatic cleaning system.



Eurofilter NG VS M|P

Eurofilter NG VS with a single hopper with rotary valve, in order to facilitate the discharge of powders into larger containers (containers not provided) than standard collection bins can hold -optimal when we treat volumes of pollutant higher than usual applications. Available Base frame h 1500mm with electrical pane optional.



Eurofilter NG BRIC M|P

Eurofilter NG BRIC with a single hopper and briquette pressing machine, in order to facilitate the discharge of dust and simultaneously reduce the volume of waste material, in briquettes. This version is useful when there are very large volumes of pollutant and small sized space storages for waste material.

Technical features

Technical features		Model Eurofilter NG					
		M 160 P160	M 200 P 200 VS M P 200	M 250 P 250 VS M P 250	M 300 P 300 VS M P 300 BRIC M P 300	M 350 P 350 VS M P 350 BRIC M P 350	
Power	KW	3	4	5,5	7,5	11	
Max. air flow	m ³ /h	2000	3000	5000	6000	8000	
Nominal air flow	22m/s	1502	2487	3886	5595	7616	
Filtering area	m ²	12	17	23	29	38	
Static available pressure	Pa	2200	2600	2800	2900	3000	
Inlet diameter	mm	160	200	250	300	350	
Standard power supply	V	400	400	400	400	400	
	Hz	50	50	50	50	50	
Absorption	A	5,85	7,45	10,2	13,9	18,9	
Noise level	dB(A)	66	69	70	72	74	
Type of filter media		POLYESTER					
Filter fabric weight	gr/m ²	500	500	500	500	500	
N. Collection bins		1	2	2	3	3	
Bin capacity	l	200 x 2	200 x 2	200 x 2	200 x 3	200 x 3	
N. of bags	Ø125mm	24	36	48	60	60	

Standard Components

NG P | NG VS P | NG BRIC P



Economiser

NG P | NG VS P | NG BRIC P

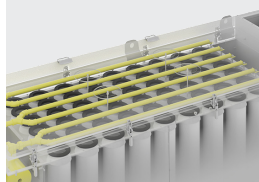

Automatic cleaning with pneumatic system (P)

NG M | NG VS M | NG BRIC M



Automatic cleaning with motor vibrator (M)

NG VS



Control panel

NG | NG VS | NG BRIC

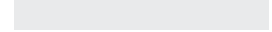

Automatic remote start

Options

NG | NG VS | NG BRIC



Ahead with remote control

NG | NG VS | NG BRIC



Ahead with inverter

NG | NG VS | NG BRIC



Fire damper with manual reset

NG | NG VS | NG BRIC



Motorised air shutter

NG | NG VS | NG BRIC



Bag M PES 550AX

NG VS



Base frame h 1500mm with electrical panel depending on type of use

NG VS



Electrical panel with Ahead BASE

NG VS



Electrical panel with inverter

NG | NG VS | NG BRIC

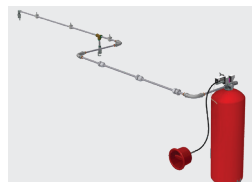

Automatic fire prevention system using powder extinguisher

NG | NG VS | NG BRIC

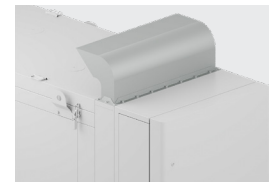

Section ejection

NG | NG VS | NG BRIC

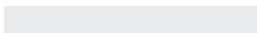

Manual water fire prevention system complete with Splinkler

NG | NG VS | NG BRIC

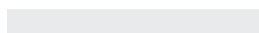

Fire prevention system automatically water-operated, complete with Splinkler

NG | NG VS | NG BRIC

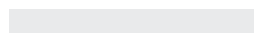

Painting

Overall dimensions

Eurofilter NG M/P

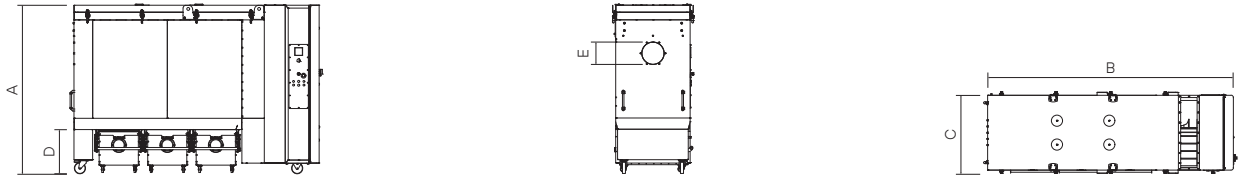

Eurofilter NG VS M/P

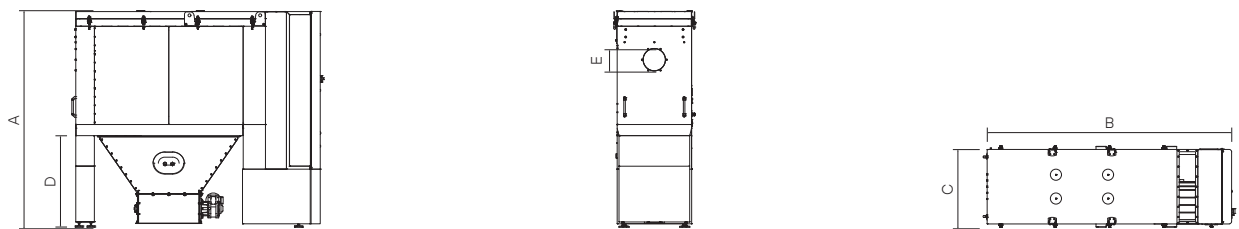

Eurofilter NG BRIC M/P

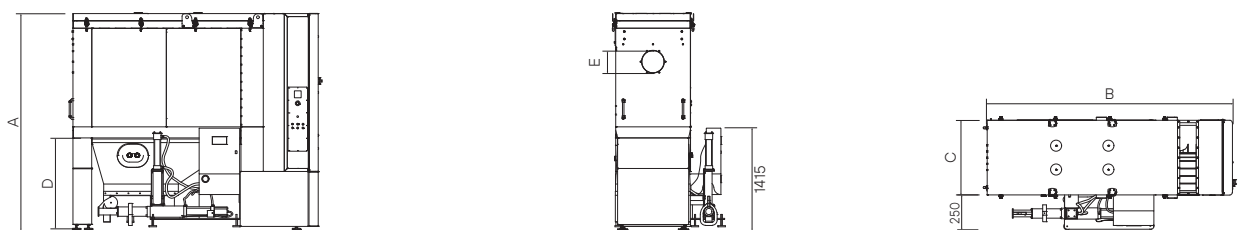

MODEL	DIMENSIONS (mm)				
	A	B	C	D	E
Eurofilter NG M/P 160	2260	1785	1090	595	160
Eurofilter NG M/P 200	2260	2530	1090	595	200
Eurofilter NG M/P 250	2260	2530	1090	595	250
Eurofilter NG M/P 300	2260	3285	1090	595	300
Eurofilter NG M/P 350	2260	3285	1090	595	350
Eurofilter NG VS M/P 200	2900	2530	1090	1230	200
Eurofilter NG VS M/P 250	2900	2530	1090	1230	250
Eurofilter NG VS M/P 300	2900	3285	1090	1230	300
Eurofilter NG VS M/P 350	2900	3285	1090	1230	350
Eurofilter NG BRIC M/P 300	2900	3285	1090	1230	300
Eurofilter NG BRIC M/P 350	2900	3285	1090	1230	350

Packaging information

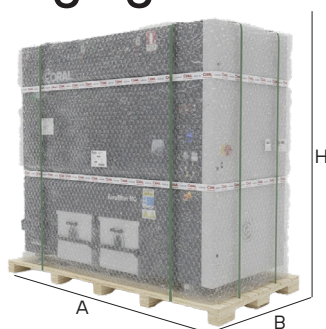

MODEL	PLATFORM N.	DIMENSIONS (mm) AxBxH	WEIGHT (kg)
Eurofilter NG M/P 160	1	2100 x 1200 x 2400	700
Eurofilter NG M/P 200 250	1	2800 x 1200 x 2400	1000
Eurofilter NG M/P 300 350	1	3500 x 1300 x 2450	1100
Eurofilter NG VS M/P 200 250	1	2800 x 1200 x 2400	1000
Eurofilter NG VS M/P 300 350	1	3500 x 1300 x 2450	1100
Eurofilter NG BRIC M/P 300 350	1	2300 x 1150 x 2250	1070
Eurofilter NG VS Filter extensions	1	1200 x 800 x 600	80
Eurofilter NG VS hopper	1	1300 x 800 x 700	200

All images and values on this catalogue are indicative and can be subject to modification and improvements. CORAL reserves the right to change them without previous advice.



Made in Coral

Coral manufactures 100% of all the components that are part of an industrial extraction system within their facilities in Volpiano, just outside of Turin. The quality of materials that we use and our industry experience guarantee a production of high level in everything we make.

ITALIA

MILANO	p: +39 02 95.30.1003
TORINO	p: +39 011 99.80.141
VICENZA	p: +39 0444 34.93.98
BOLOGNA	p: +39 051 69.26.335

FRANCE

LYON	p: +33 4 74 944 562
PARIS	p: +33 1 60 868 069
POITIERS	p: +33 5 49 379 596

GERMANY

LEVERKUSEN	p: +49.214.312.663.20
------------	-----------------------

UNITED KINGDOM

LITTLEBOROUGH ROCHDALE	p: +44 1 706 377344
------------------------	---------------------

MIDDLE EAST

DUBAI UAE	p: +971 56 1028130
-----------	--------------------

INDIA

BANGALORE	p: +91 734 888 2333 - 2777
-----------	----------------------------

SINGAPORE

SINGAPORE	p: +65 88338991
-----------	-----------------

U.S.A.

KYLE, TX	p: +1 480 796 5352
----------	--------------------



CORAL s.p.a.
 Corso Europa, 597 10088
 Volpiano (Torino) ITALY

p: +39 011 98.22.000
 e: info@coral.eu

coral.eu



For a cleaner future.